

mothercare



reno

user guide

IMPORTANT. KEEP FOR
FUTURE REFERENCE

The Reno has a multi position reclining backrest, for use by babies from birth in the reclined position and 6 months in the upright position.

The Reno has a removable seat pad for baby's comfort, lockable swivel wheels for easy steering, a basket for carrying up to 2 kilograms of shopping and baby items, a parent tray (weight limit 1kg) with drink holder, a detachable bumper bar, and a hood.

The recommended weight limit for the seat is 15kg.

diagram

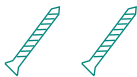
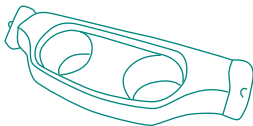
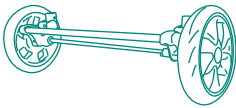

description

swivel wheel unit (2)

rear axle assembly

bumper bar

parent tray

parent tray fixing screws (2)

to unfold

1

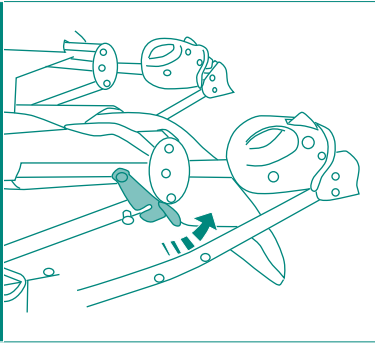

Release the folding catch at the side of the chassis.

2

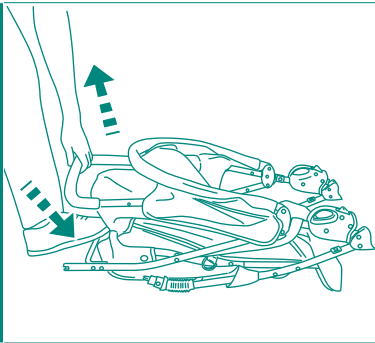

Hold the back bar (not the brake bar, once fitted) down with your toes and lift the handle.

3

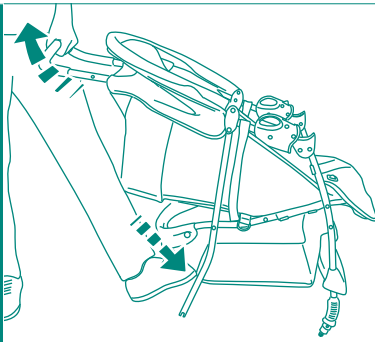

Lift the handle until the locks on both sides are fully secured.

fitting the wheels & parent tray

4

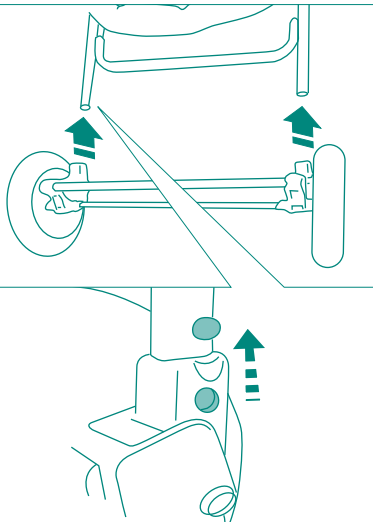

Align and fit the rear wheel assembly onto the rear legs by sliding each side of the mounts along the legs until the pins are located inside the circular holes in the plastic.

5

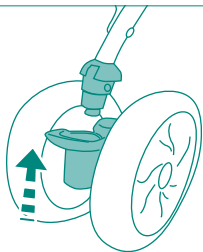

Push the front swivel wheels up on to the swivel wheel mounts until they click into position. Check they are secure by pulling downwards.

6

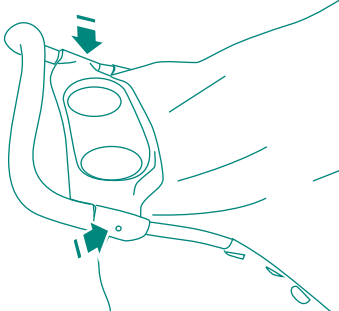

Attach the parent tray to the upper handle as shown, securing with the screws in the positions shown by the arrows.

footrest

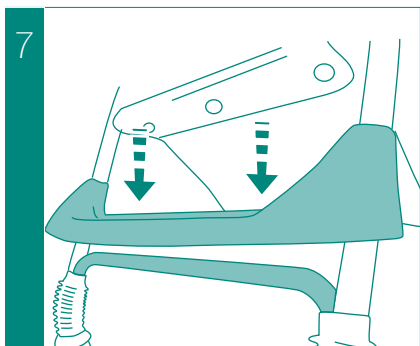

Press the footrest down onto the cross tube, so it connects securely to it.

bumper bar

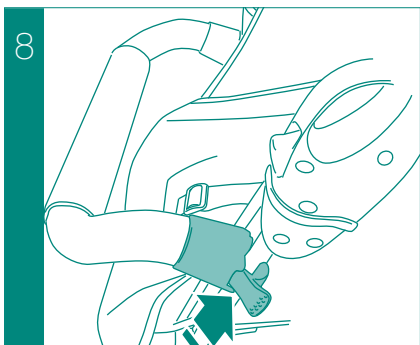

Open the clips and attach the bumper bar to each side of the chassis, just below the locks.

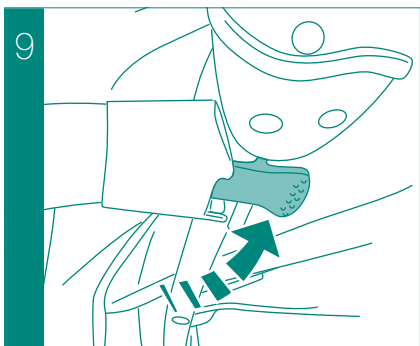

Secure by closing each of the clips.

Note: The bumper bar cover can be removed for cleaning. Sponge cleaning is advised.

reclining the seat

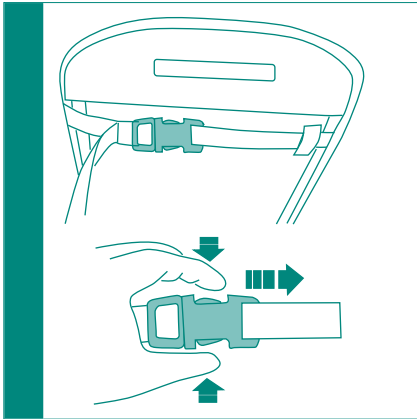

The seat can be reclined to a choice of positions. Press the release buckle behind the seat to fully recline it, or adjust the strap for other angles.

hood

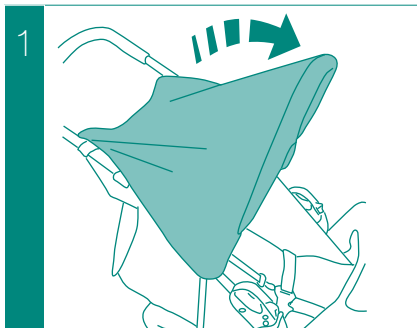

Push the hood forwards to open, or back to close.



The back apron of the hood can be attached to the sides of the backrest to keep draughts out. Fasten the velcro tabs where shown.

harness

1

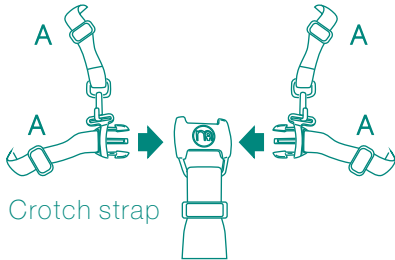

To fasten
Insert both fasteners securely into
the clasp.
Adjust each strap length with
adjusters A.

2

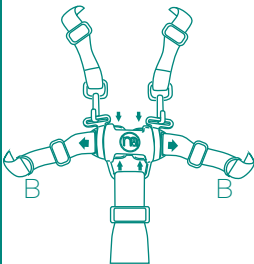

To release
Press the fastener prongs and pull apart.
'D' rings (B) are provided for fitting a separate
harness complying with BS 6684.

Your child should be securely harnessed
at all times and should never be left
unattended, even for short periods.

swivel locks

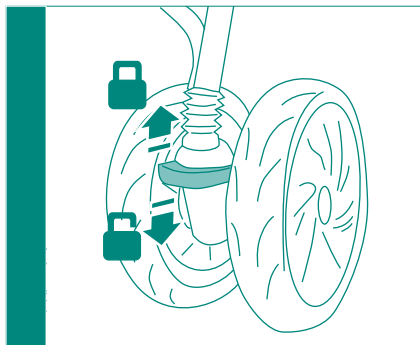

To lock the swivels - align the front wheels and raise each lock.

To unlock the swivels - push down on each lock.

brakes

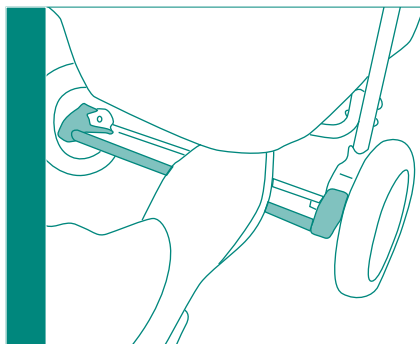

Push down on the metal bar to fully engage the brakes.

Pull up to release the brakes.

Check that the brakes have engaged correctly by gently pushing the pushchair.

to fold

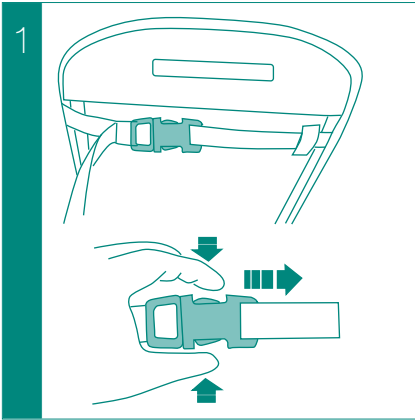

Release the buckle behind the seat to recline it fully.



Press the side button (1) on the right hand lock inwards, and press the buttons (2) on both locks downwards.

3

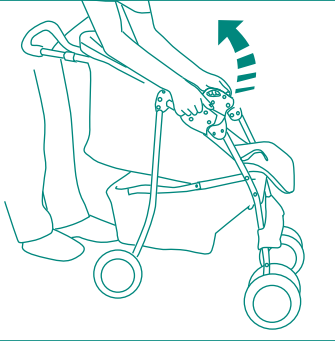

While holding the buttons down, lift the locks and press the handle backwards to fold.

4

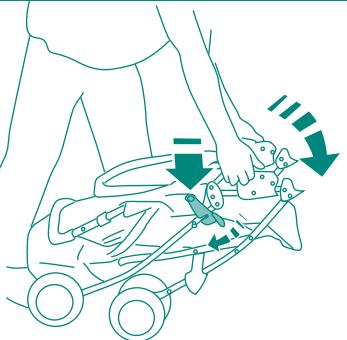











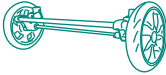

Close the pushchair completely and fasten the storage latch.

- Your pushchair requires maintenance by you.
- Regularly inspect the locks, brakes, harness, catches, seat adjusters, joints and fixings to ensure they are secure and in full working order.
- Brakes, wheels and tyres do wear and should be replaced if necessary. This can be arranged through your local Mothercare store.
- If parts become stiff or difficult to operate, ensure dirt is not the cause, then try a light application of a silicone lubricant, ensuring it penetrates between the components. Regular lubrication of moving parts will extend the life of your pushchair and make opening and folding easier.
- Plastic and metal parts may be sponged clean with warm water and a mild detergent.
- The seat may be cleaned by sponging lightly using warm water and a mild detergent. Dry thoroughly before storing.
- Never clean with abrasive, ammonia based, bleach based or spirit type cleaners.
- After exposure to damp conditions, dry off with a soft cloth and leave fully open in a warm environment. Storing damp will encourage mildew to form. Store in a dry safe place.
- Do not leave in sunlight for prolonged periods - some fabrics may fade.
- Your pushchair should be serviced and reconditioned before using it for a second baby, or within 18 months, whichever is the sooner. This can be arranged by your local Mothercare store.

- **WARNING! YOUR CHILD'S SAFETY IS YOUR RESPONSIBILITY.**
- Designed and tested to comply with BS 7409:1996.
- Do not allow your child to climb unassisted into the pushchair.
- Ensure your child wears a correctly fitted and adjusted harness at all times. For extra safety, D-rings are provided for a separate safety harness approved to BS 6684.
- Ensure children are clear of moving parts before making adjustments.
- Overloading and incorrect folding may damage or break this pushchair.
- Never leave raincovers, hoods or aprons on indoors, in a hot atmosphere or near a heat source - your child may overheat.
- Do not use replacement parts or accessories, e.g. child seats, bag hooks, raincovers etc. other than those approved by Mothercare as they may make the pushchair unsafe.
- Do not overload with additional children, goods or accessories. Bags and other items must not be hung from the handle.
- Always apply the brakes when stationary.
- Be careful when going up or down kerbs. Remove your child and fold the pushchair when going up or down stairs or escalators.
- Do not use your pushchair in a manner for which it is not designed.
- Do not let children play with or hang on to the pushchair.
- Hold on to your pushchair when close to moving road vehicles or trains. Even with the brake on, the draught from the vehicle may move the pushchair.
- If your pushchair is used by someone unfamiliar with it e.g. grandparents always show them how it works.
- Never leave your child unattended, even for the shortest time.

The replacement parts listed below are available for your product. In the event that you require any of these parts, please contact your local Mothercare store or contact customer care on 08453 30 40 30. Alternatively write to Mothercare, Customer Care, Cherry Tree Road, Watford, WD24 6SH or visit us at www.mothercare.co.uk.

Other parts may be repairable by returning the stroller to Mothercare.

diagram	description
	rear axle assembly
	front wheel assembly
	parent tray
	bumper bar
	hub cap
	hood
	buckle
	waist strap
	recline strap
	seat unit
	seat pad
	basket