



# IMPORTANT!

You must ensure that you follow these instructions carefully and correctly. If this seat is not fitted securely and your child is not strapped in correctly, your child and other passengers are at serious risk of injury in the event of an accident

## Please read this User Guide carefully BEFORE trying to install your child car seat

The Hampshire Trading Standards Authority and Britax advise that child car seats should not be bought or sold second-hand. Please dispose of your child seat safely. Do not sell or pass it on.

After an accident, the child seat and your car seat belts should be replaced. Although they may look undamaged, if you were to have another accident the child seat and your car seat belts may not be able to protect your child as well as they should.

### No child seat is escape proof

Harness systems cannot be designed to be completely "child proof" and yet comply with the legal requirements of European Standard ECE R44. The harness must be fastened and adjusted correctly at all times and children encouraged to remain within the harness system.

### Looking after your child seat

Food and drink may find their way inside the buckle of the harness. This can stop it from working properly – it will not click. Wash in warm water until clean (dia A and B).

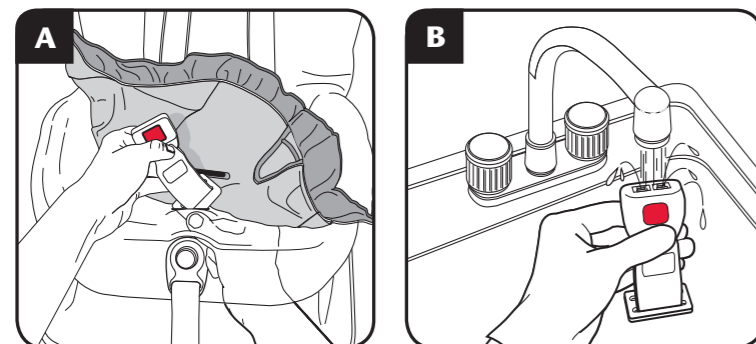

### Cleaning the cover

Please read the labels on the cover for washing instructions. **DO NOT** tumble dry the cover – short spin and drip dry only.

### Cleaning the harness and seat shell

Sponge clean **ONLY** using hand soap and warm water. **DO NOT** take apart, or attempt to take apart, any part of the harness or seat when cleaning.

**DO NOT** use solvents, detergents or washing-up liquid as these may weaken the harness and the seat.

**DO NOT** lubricate or oil any part of the seat.

### Removing and refitting the cover

Press in and hold the harness adjuster tab and with your hand below the chest pads pull **BOTH** shoulder straps forwards as far as they will go, see overleaf (dia 1b).

Pull the cover from the top of the seat, unfasten the buckle and bring the straps through the shoulder strap slots to the back of the seat, using the method described overleaf (dia 1e). Remove the comfort pad by unfastening the hook and eye strip and gently pull the cover off the seat, easing the shoulder straps, chest pads, harness buckle and adjuster strap through the slots in the cover.

To re-fit the cover, reverse the method above. When re-fitting the shoulder straps make sure they are not twisted.

**IMPORTANT** – If using a child seat which is fitted with ISOFIX interface bars do not thread any part of the harness outside of them.

**IMPORTANT** – The cover is a safety feature. **NEVER** use the child seat without it. Don't put your child's safety at risk by using other makes of replacement cover, they could stop the child seat from protecting your child as well as it should.

A replacement cover is available from your Britax stockist or contact Britax Customer Service Helpline on 01264 386034.

### Use of your Cosy Tot Premium with a compatible Britax Travel System

**IMPORTANT** – To attach your Cosy Tot Premium to a compatible Britax chassis, please see the user guide supplied with your Travel System or socket attachments. If you have lost your user guide then further copies can be downloaded from the Britax website @ [www.britax.eu](http://www.britax.eu) or available from the Customer Service Helpline on 01264 386034.

### Guarantee

All Britax products are carefully designed, manufactured and tested. However, should this product prove faulty within 12 months of purchase due to a materials or manufacturing fault please return it to the original place of purchase. We will then, at our discretion, either repair it with of charge or replace it with the same or a similar product.

For guarantee purposes proof of purchase will be required. We recommend that you retain your receipt and attach it to this user guide. They should be kept in a safe place.

Britax does not accept liability for damage arising from abuse, misuse or negligence. This guarantee is not transferable and therefore does not apply to second-hand products.

Your statutory rights are not affected by this guarantee.

### Possible seating positions

(providing that the child seat can be fitted in accordance with the user guide)

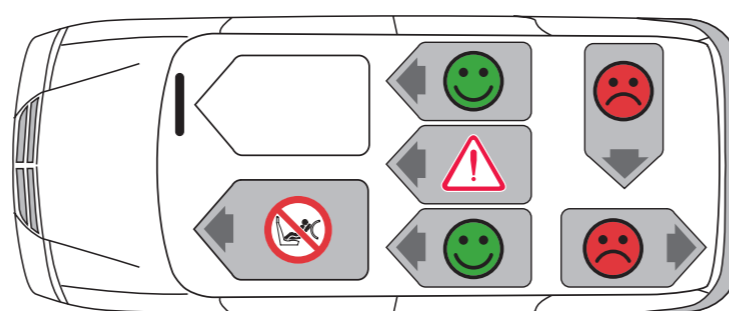

### If in doubt

Not all car seats fit all cars. For advice as to the suitability of this restraint for your car please use **Fit-finder** on our website at [www.britax.eu](http://www.britax.eu), call our Customer Service Helpline on 01264 386034 or email [helpline@uk.britaxeurope.com](mailto:helpline@uk.britaxeurope.com).

## WARNING



### EXTREME HAZARD!

**DO NOT** under any circumstances use a rearward facing child seat on a passenger seat fitted with an active airbag. DEATH or SERIOUS INJURY can occur.

**DO NOT** use the child seat on side facing vehicle seats.

**DO NOT** use anything, such as a cushion or coat, to raise the child seat off the passenger seat. In an accident the child seat and your car seat belts would not be able to protect your child as well as they should.

**DO NOT** attempt to dismantle, modify or add to any part of the child seat or change the way its harness or your car seat belts are made or used. The official approval is no longer valid if modifications are made. **NO** modifications may be made to the child seat other than by the manufacturer.

**DO NOT** use the child seat without the cover fitted.

**DO NOT** leave loose objects, such as luggage or books, in the back of your car. They must be properly secured, because if you have to stop your car suddenly loose objects will keep moving and can then cause serious injuries. Large and heavy loose objects are a particular risk.

**DO NOT** leave folding passenger seats unlatched. If you have to stop your car suddenly a loose seat back could injure your child.

**DO NOT** leave your baby unattended in an infant carrier, even for a short time.

**DO NOT** leave children alone in your car, even for a short time.

**DO NOT** allow children to play with or adjust the child seat.

**DO NOT** place the child seat on a table or work-top.

**DO** cover the child seat if your car is left in direct sunlight. Fittings can become hot to touch in sunny weather and the cover may become faded.

**DO** keep this user guide in the user guide storage slot.

**DO** make sure that the child seat does not become trapped by a folding passenger seat or in the door of your car.

**DO** make sure that you adjust the harness to fit the clothes your child is wearing before each journey – a fitting for winter clothes may be too slack for a child wearing summer clothes.

**DO** store the child seat in a safe place when it is not being used. Avoid placing heavy objects on top of it and do not store near direct heat sources or in direct sunlight.

**DO** always keep the child seat secure, even if it is not being used by your child.

**DO** make sure that all occupants in the vehicle are correctly restrained.

**DO** use the safety harness provided with the child seat at all times.

**DO** make sure when using the child seat with a travel system, that it is securely attached to the travel system chassis before setting off.

**DO** make sure the handle is upright and latched properly before carrying your baby in the child seat.

**DO** watch over your baby when using the rocking feature. At all other times make sure the handle is in the stable position to prevent rocking.

### When using Britax ISOFIX base

**DO NOT** place anything in the footwell immediately in front of an installed ISOFIX base.

**DO NOT** allow an installed child seat to lie in contact with the vehicle seat immediately in front of it.

**DO** make sure that your child seat features ISOFIX interface bars.

**DO** make sure that it is firmly latched to its anchor points.

**DO** make sure that the stability bar is correctly adjusted.

**DO** make sure that the support leg is in contact with the vehicle floor.



**IMPORTANT** – The ISOFIX base should only be used with vehicles which appear on the supplied applications list. An up-to-date copy of the list can also be found on the Britax website – [www.britax.eu](http://www.britax.eu)

Britax, whilst taking into account child car seat contact with vehicle seats throughout the development of new products, cannot accept responsibility for damage occurring to vehicle seats or seat belts.



**IMPORTANT** – The child seat **MUST** only be used with a lap and diagonal seat belt (approved to UN/ECE Regulation no. 16 or other equivalent standards).

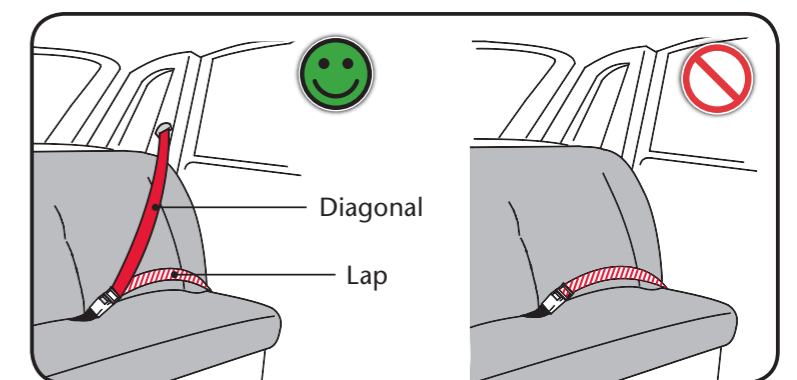

### Britax Excelsior Limited

1 Churchill Way West  
Andover  
Hampshire SP10 3UW  
United Kingdom

### A Britax Childcare company

Customer Service Helpline: 01264 386034  
Email: [helpline@uk.britaxeurope.com](mailto:helpline@uk.britaxeurope.com)  
Switchboard: 01264 333343  
Fax: 01264 334146

[www.britax.eu](http://www.britax.eu)

## Introducing your new child car seat and ISOFIX base

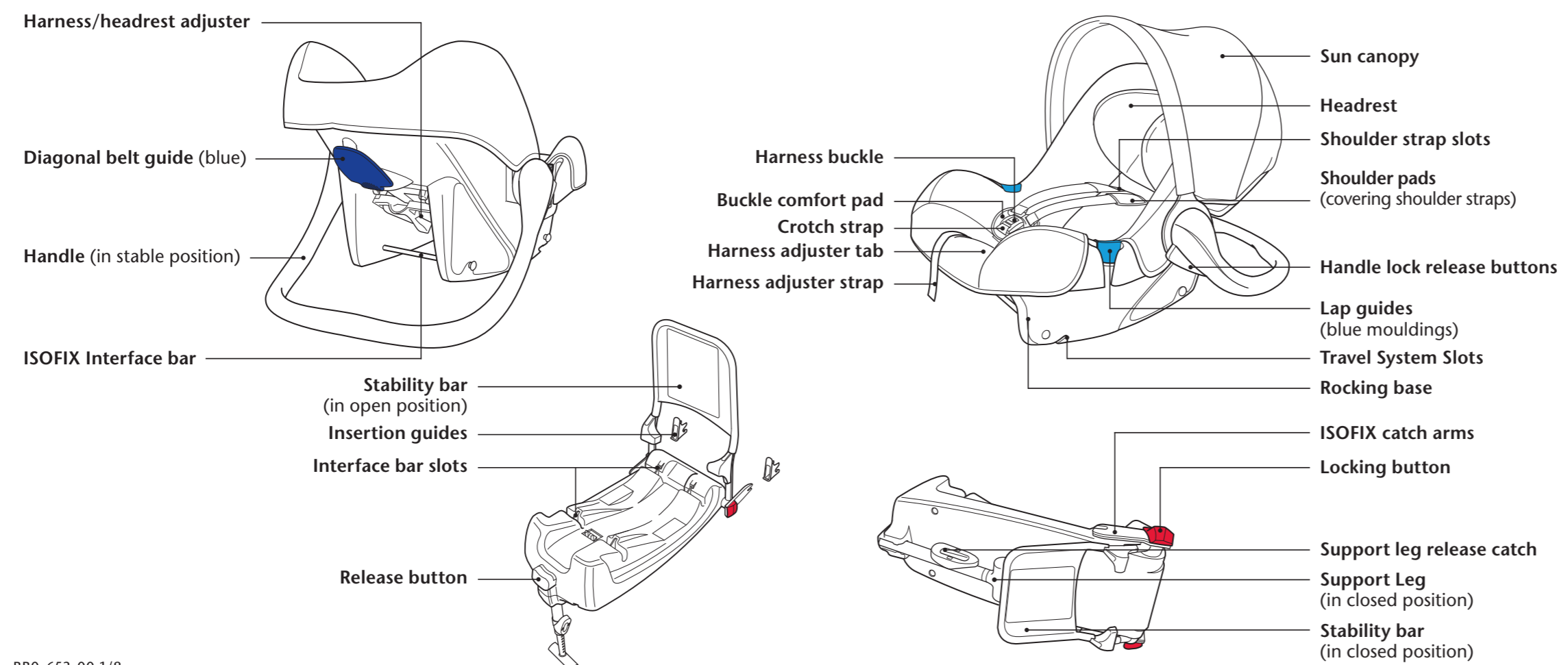

BBO-653-00 1/8



# Cosy Tot Premium

## 1. Adjusting the child seat (from birth to approx 12-15 months)

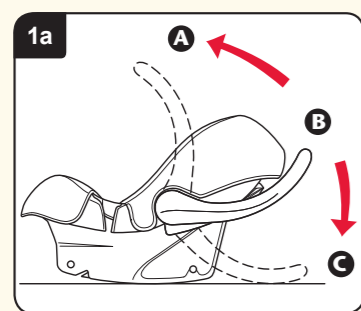

**Handle – carrying, rocking and stable position**  
To move the handle, squeeze the lock release buttons on both sides at the point at which the handle pivots to release lock and then move it to the desired position (**dia 1a**):  
**A** – Carrying position  
**B** – Rocking position  
**C** – Stable position  
**IMPORTANT** – Always check the handle is upright and latched properly before carrying.

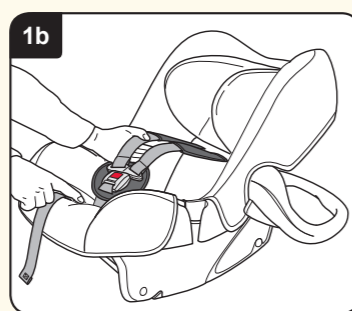

**Harness adjustment**  
**IMPORTANT** – You must adjust the shoulder straps of the harness to the correct position for your child **BEFORE** installing the child seat as it cannot be adjusted in the car. Carefully place the child seat on the floor. Move the handle to the stable position, **C**. With one hand press the harness adjuster tab through the slot in the cover. With your other hand pull **BOTH** shoulder straps forward

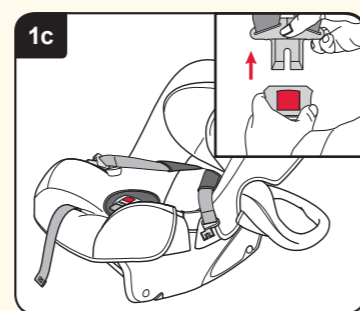

as far as possible to loosen the harness (**dia 1b**). Unfasten the harness by pressing the red harness buckle button. Lay the shoulder straps over the sides of the seat (**dia 1c**). Place your child in the child seat and check that the shoulder strap slots are level with or just below your child's shoulders and that the head is comfortably positioned in the headrest (**dia 1d**).



To adjust the height of the headrest and shoulder straps lift the headrest adjuster at the back of the seat shell and slide the headrest up or down to the desired position. When the headrest is in the correct position let go of the headrest adjuster and ensure it has locked into place (**dia 1e**).

**IMPORTANT** – If using a child seat which is fitted with ISOFIX interface bars do not thread any part of the harness outside of them.

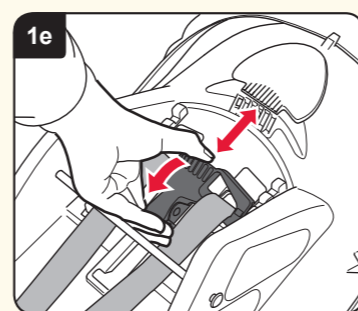

Once you reach the top height of the Adjusta-Fit System your child may continue to use the child seat until their weight exceeds 13kg, or the top of their head reaches the top of the seat shell.

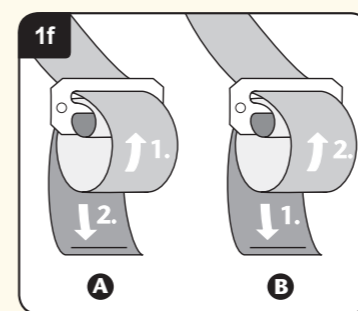

**Adjusting the crotch strap**  
**IMPORTANT** – The buckle should always be positioned low down on your child's body. You must adjust the crotch strap to the correct length for your child **BEFORE** installing the child seat as it cannot be adjusted in the car.

a. The crotch strap should only be extended when normal harness adjustment is not enough, i.e. shoulder straps are at full extension.

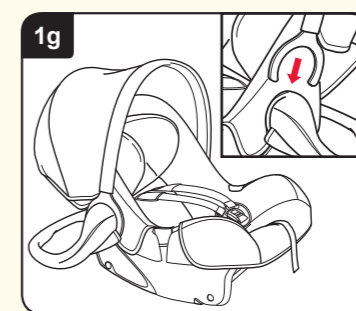

b. Always return the crotch strap to its original, shorter length when using the seat with a smaller baby.  
c. **DO NOT** attempt to remove the crotch strap from the adjuster. Adjustment is made by feeding the crotch strap through the adjuster (**dia 1f**).  
Move the handle to the stable position **C** (**dia 1a**). Through the slot in the cover, press the harness adjuster tab with one hand. With your other hand pull

the shoulder straps forward as far as possible to loosen the harness. The adjuster at the end of the crotch strap is found under the front edge of the child seat. To change the length of the crotch strap thread it through the adjuster in the direction of the arrows shown (**dia 1f**).

**Using the sun canopy**  
To fit the canopy place it over the back of the child seat. Then press the clasps on either side of the sun canopy onto the handle mounting until they 'grip'.

## 2. Fitting your child in the child seat

**Everyday use of the harness**  
**IMPORTANT** – Have you adjusted the harness to the correct position for your child? If not, see 'Harness Adjustment'. Move the handle to the stable position. Unfasten the harness. Press the harness adjuster tab through the slot in the cover. Pull **BOTH** shoulder straps forward as far as possible to loosen the harness. Lay the shoulder straps over the sides of the seat. Place your child in the child seat and fit the harness loosely around them. Re-fasten the harness buckle, pushing them firmly together until you hear a click. Make sure the harness is not twisted.

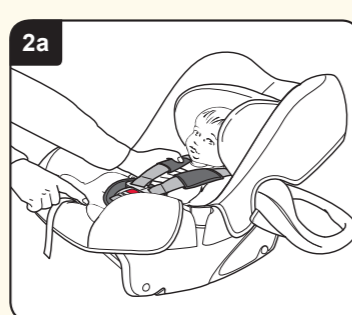

Tighten the harness by pulling the adjuster strap forward making sure the harness is a comfortable but **FIRM** fit around your child. To remove your child from the child seat, loosen the harness by pressing the harness adjuster tab down as you pull the shoulder straps forward. Then release the harness (**dia 2a**).

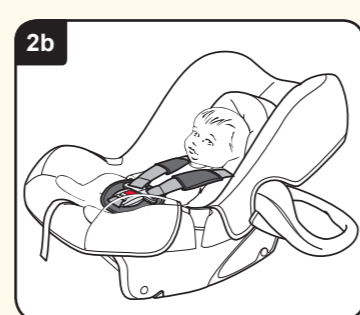

**IMPORTANT** – Your baby should not stay in the child seat for periods exceeding 2 hours at a time.  
**Using as a low chair**  
With the handle in the carrying or rocking position, the child seat will rock gently as your baby moves. With the handle in the stable position as shown (**dia 2b**), the child seat becomes a steady seat for feeding or sleeping.

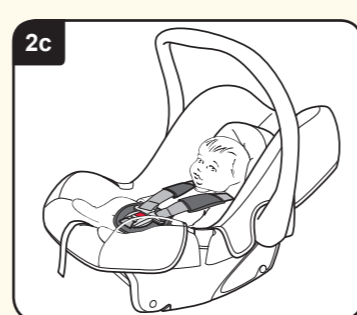

**IMPORTANT** – The safety harness provided with the child seat **MUST** be used at all times.  
**Carrying your child in the child seat**  
Always check the handle is upright and latched properly before carrying (**dia 2c**).

## 3. Installing the child seat in a car

**IMPORTANT** – Have you adjusted the harness to the correct position for your child? If not, see 'Harness adjustment'. The safety harness provided with the child seat must be used at all times.  
**IMPORTANT** – The child seat must only be fitted rearward-facing, that is with your baby facing the back of the car, using a lap and diagonal seat belt and **NOT** a lap-belt only.

**Installing with a lap and diagonal seat belt**  
To gain adequate length from your seat belt it may be necessary to slide the vehicle seat as far back as it will go (as you would for a tall person), and lower the height of the seat belt, if this is adjustable. Place the child seat on a car seat with your baby facing the back of the car.

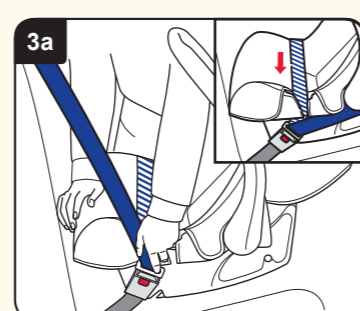

Fasten the seat belt across the child seat, making sure there are no twists in the seat belt when fitted. Pass the lap section of the seat belt through the lap guides on both sides as indicated by the blue plastic mouldings on the child seat (**dia 3a**).

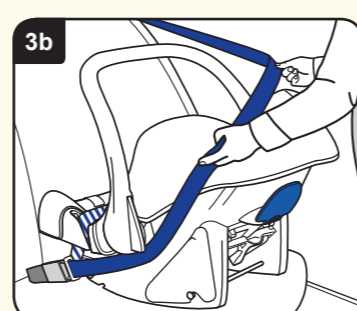

Place the handle in the carrying position. Pull the diagonal section of the seat belt around the back of the child seat (**dia 3b**).  
**IMPORTANT** – If you have installed the child seat with a P-Type travel chassis adaptor attached, the seat belt **MUST** go around the outside of the

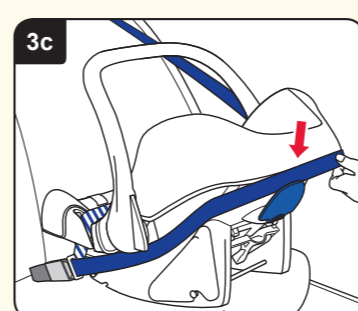

adaptors, not underneath. Feed the diagonal belt through the blue diagonal belt guide on the back of the child seat (**dia 3c**).

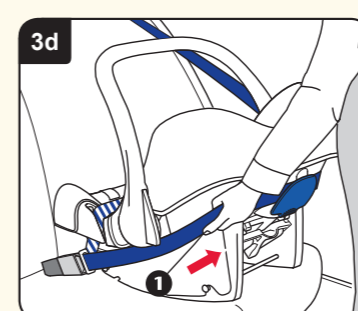

Support the child seat, then tighten the seat belt by first pulling here **1** (**dia 3d**) and then here **2** (**dia 3e**) to remove any slack. Check that the child seat feels secure.

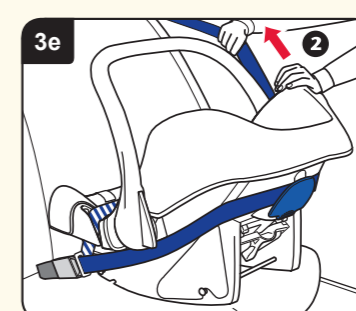

**ENSURE THAT:**  
a. The lap section of the vehicle's seat belt **A** runs through both belt guides **B** on the child seat (**dia 3f**).  
b. The diagonal section **C** runs through the diagonal belt guide on the back of the seat (**dia 3c**).

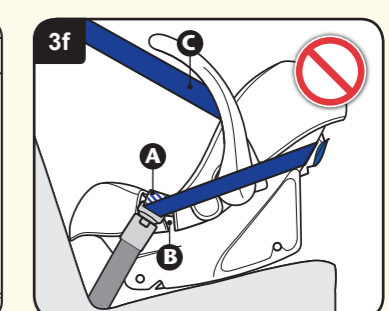

c. The car seat belt buckle is not positioned in front of the lap guides **B** (**dia 3f**).

## 4. Installing the child seat in your car using an ISOFIX base

**IMPORTANT** – For advice as to the suitability of the ISOFIX Base for your car please call Customer Services on 01264 386034 or visit [www.britax.eu](http://www.britax.eu)  
Only a child seat fitted with ISOFIX interface bars should be used with an ISOFIX base. The ISOFIX base is suitable only for use in the car.  
**Installing with ISOFIX fixings**  
If your vehicle is not equipped with ISOFIX insertion guides, you may wish to use the two provided with the ISOFIX base. Clip the two insertion guides onto the two ISOFIX anchorage points on the vehicle seat (between the seat and the backrest).

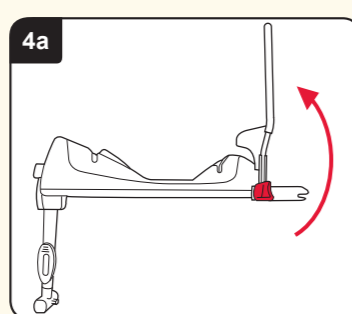

The cut-out on the insertion guide must point upwards (**dia 4b inset**). Open out the support leg on the underside of the ISOFIX Base. Open the stability bar in the direction of the arrow (**dia 4a**).

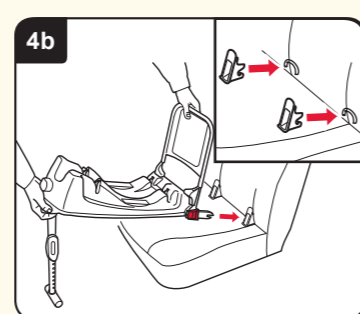

**IMPORTANT** – The ISOFIX base will not allow the child seat to latch into place unless the support leg is in the open position. Guide the two catch arms into the insertion guides (**dia 4b**).

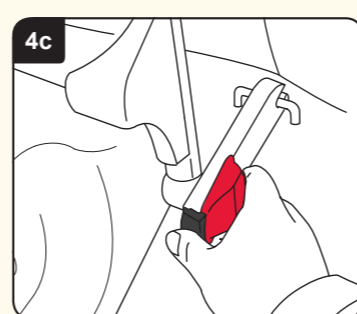

Place your thumb on the locking button and press it firmly until you feel the system latch (**dia 4c**). Ensure that you feel and hear the locks engage (click) and you can see that the green section around the locking button is extended. Repeat for the other side of the seat.

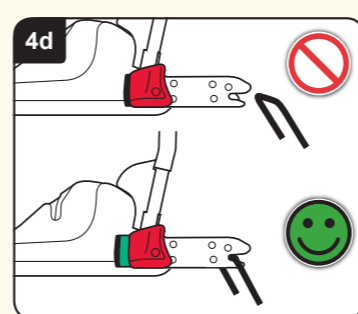

Pull on the base to ensure both catches are properly engaged (**dia 4d**). Extend the support leg by squeezing the release catch. It is essential that the leg touches the vehicle floor. (**dia 4e**).

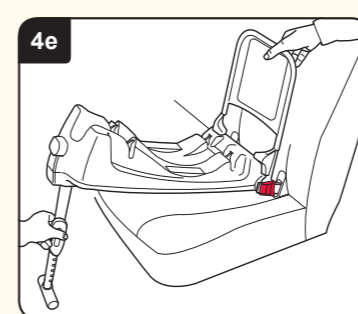

**IMPORTANT** – NEVER put anything under the support leg. It must always be in direct contact with the vehicle floor. Lower the child seat onto the base ensuring that the interface bars are guided into the slots. Keep the child seat as level as

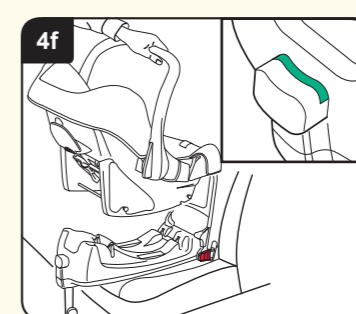

possible (**dia 4f**) to allow an easy engagement into the slots. Push down on the child seat until you feel and hear a click.  
**IMPORTANT** – You must check that the child seat is fully engaged with the ISOFIX base by pulling up on the child

seat handle. It is only correctly latched when the green area is visible (**dia 4f inset**).  
To remove the child seat from the base, press the large button in on the front of the base until the green area no longer shows and lift the child seat clear.  
**Removing the ISOFIX base from the car**  
To release the ISOFIX base, press and hold the locking button whilst squeezing the red button on one side of the seat. Repeat for the other side. Squeeze the support leg release catch and retract the support leg to its shortest length so that it latches into the first hole. It can now be folded against the interface.