

IMPORTANT-RETAIN FOR FUTURE REFERENCE

PLEASE READ CAREFULLY

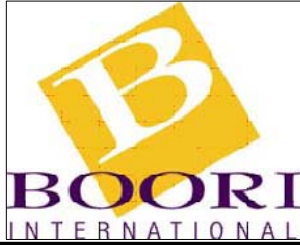

Boori International

AUSTRALIA
27-37 Vallance Street
St.Marys NSW
2760 Australia
Ph: 02 9833 3769 Fax: 02 9673 4240

Boori UK Limited

UNITED KINGDOM
Wells house,Unit.5
Woolley Barns,Woolley
Wantage,OX12 8TA UK
Ph: 44 14 8863 9500 Fax: 44 14 8863 9505

Instructions for the Classic Cot/Bed

Cot Hardware and parts list

2 X Allen Keys	4 x Drop side glide pins	4 x Capping nuts	4 x 40mm Connecting bolts	4 x 70mm Connecting bolts (for fixed side only)	4 x 80mm Connecting bolts (for base only)
	A	L	E	I	J

Actual size

Actual size

Actual size

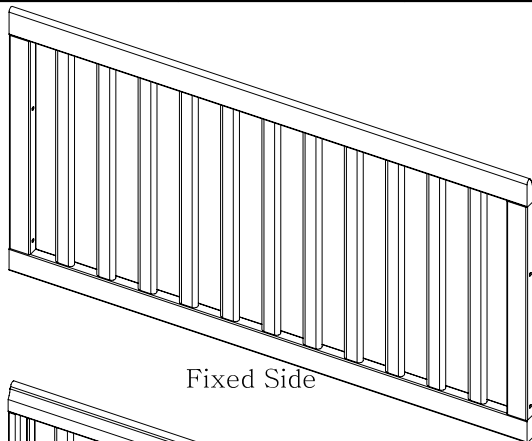

Fixed Side

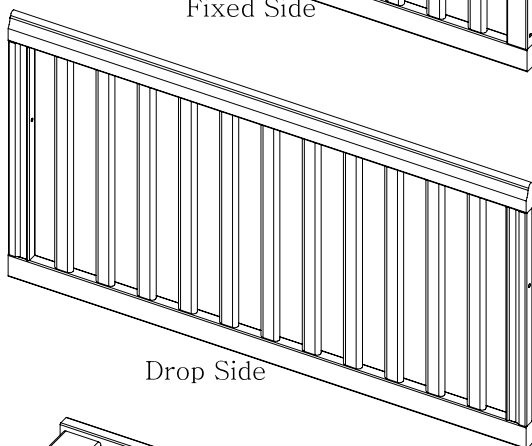

Drop Side

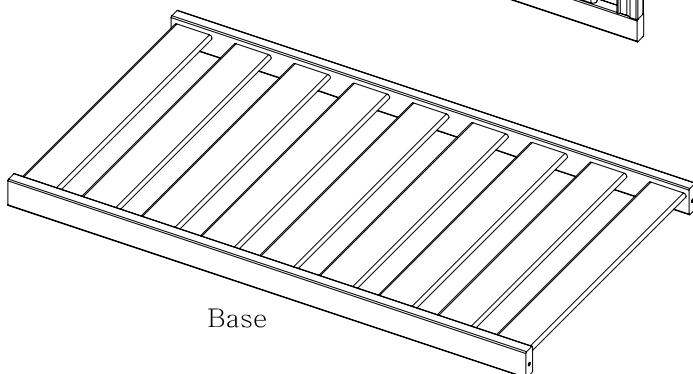

Base

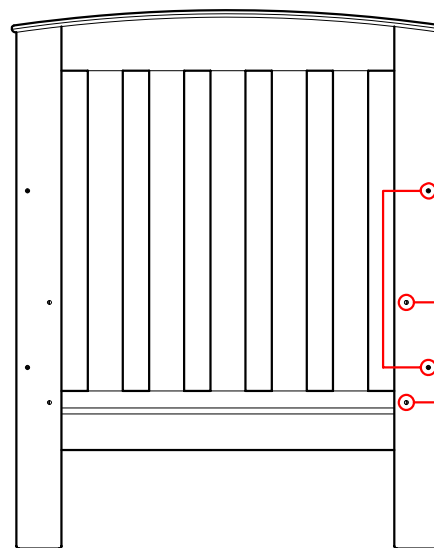

2X End Panels (Identical)

Glide Pin Holes

Top Hole
(For high base position)

Bottom Hole
(For low base position)

CLASSIC COT/ BED assembly instructions

FOR AUSTRALIA AND NEW ZEALAND

(AS/NZS 2172:2003)

RECOMMENDED MATTRESS SIZE 1310mm X 750mm X 110mm

This cot has been manufactured for use with a mattress which measures 750mm wide by 1310mm long and a maximum thickness of 120mm. The width and length are specified because it is important that the gaps between the mattress sides and ends of the cot will not exceed 40mm. This is to minimise the risk of a child's limb becoming caught in the gap. The thickness of the mattress has been specified to ensure that the depth of the cot is greater than 500mm with the mattress base in the lower position to minimise the risk of a child climbing or falling out of the cot.

Warning:

- * **TO ENSURE THE SAFETY, REGULARLY CHECK ALL THE CONNECTING BOLTS AND GLIDE PINS MAKING SURE THEY ARE TIGHT.**
- * **TO PREVENT FALLS OR SUFFOCATION THE MAXIMUM MATTRESS THICKNESS SHOULD NOT EXCEED 120MM.**
- * **TO PREVENT FALLS, THE MATTRESS BASE OF THIS COT SHOULD BE ADJUSTED TO THE LOWEST POSITION BEFORE THE CHILD CAN SIT UP.**
- * Follow the manufacturer's assembly instructions in detail to ensure the safety features of the cot are not compromised.
- * Ensure the cot is placed at a reasonable distance from curtains, blinds, heaters and power points.
- * Keep cot free of any toys, cushions etc that could be used as a foothold or present a danger of suffocation or strangulation.
- * Keep medication, String, elastic or small items such as money out of reach from any position in the cot.

FOR THE UK

(BS EN716-1:1996 BS EN716-2:1996)

IMPORTANT-RETAIN FOR FUTURE REFERENCE- READ CAREFULLY

RECOMMENDED MATTRESS SIZE 1310mm X 750mm x 110mm

If you leave the child unattended in the cot, always make sure that the dropside is in the highest position.

This cot has been manufactured for use with a mattress which measures 750mm wide by 1310mm long and a maximum thickness of 120mm. The thickness of the mattress has been specified to ensure that the depth of the cot is greater than 500mm with the mattress base in the lower position and 200mm with the mattress in the highest position to minimise the risk of a child climbing or falling out of the cot.

Warning:

- * **TO ENSURE THE SAFETY, REGULARLY CHECK ALL THE CONNECTING BOLTS AND GLIDE PINS MAKING SURE THEY ARE TIGHT, CARE SHOULD BE TAKEN THAT NO SCREWS ARE LOOSE BECAUSE A CHILD COULD TRAP PARTS OF THE BODY OR CLOTHING (EG. Strings, necklaces, ribbons for babies dummies), WHICH WOULD POSE A RISK OF STRANGULATION.**
- * **TO PREVENT FALLS, THE MAXIMUM MATTRESS THICKNESS SHOULD NOT EXCEED 120MM.**
- * **TO PREVENT FALLS, THE MATTRESS BASE OF THIS COT SHOULD BE ADJUSTED TO THE LOWEST POSITION BEFORE THE CHILD CAN SIT UP.**
- * Follow the manufacturer's assembly instructions in detail to ensure the safety features of the cot are not compromised.
- * Ensure the cot is placed at a reasonable distance from curtains, blinds, power points, heaters and sources of strong heat.
- * Keep cot free of any toys, cushions etc that could be used as a foothold or present a danger of suffocation or strangulation.
- * Keep medication, String, elastic or small items such as money out of reach from any position in the cot.

Maintenance of your classic Cot

- * **TO ENSURE THE SAFETY OF YOUR COT, REGULARLY CHECK ALL THE CONNECTING BOLTS AND GLIDE PINS MAKING SURE THEY ARE TIGHT, CARE SHOULD BE TAKEN THAT NO SCREWS ARE LOOSE**
- * **GLIDE PINS AND BOLTS SHOULD BE TIGHTENED EVERY FOUR TO SIX MONTHS TO ENSURE COT REMAINS STABLE**
- * **TO CLEAN YOUR COT USE A SOFT CLOTH DAMPENED WITH WATER**
- * **DO NOT USE STRONG HOUSEHOLD CLEANERS**
- * **AVOID CONTACT WITH SHARP OBJECTS**
- * **WHEN MOVING YOUR COT DO NOT DRAG, ALWAYS LIFT AND PLACE IN POSITION**

Assembly as a Cot:

Stage 1:

Connect fixed side panel to the two end panels with the 4 X70mm connecting bolts provided.(Do not tighten at this stage).

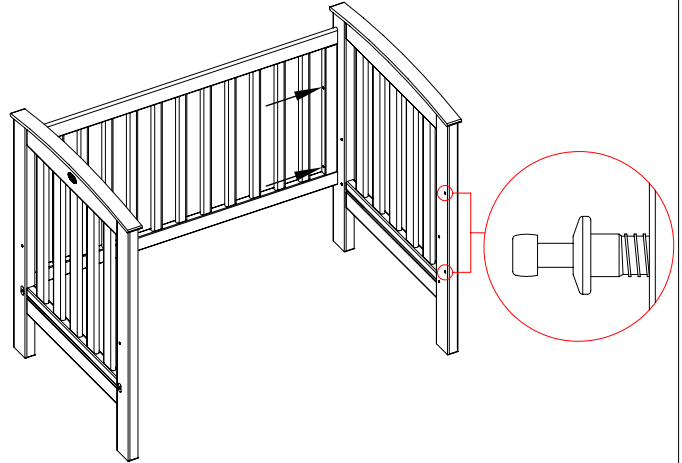

Stage 2:

Connect mattress base to the two end panels with the 4 X80mm connecting bolts provided.(Keep all bolts loose at this stage).

Note:

The upper holes on the end panels are for the high base position. Screw 4 dropside glide pins into the end panels (Make sure they are tight).

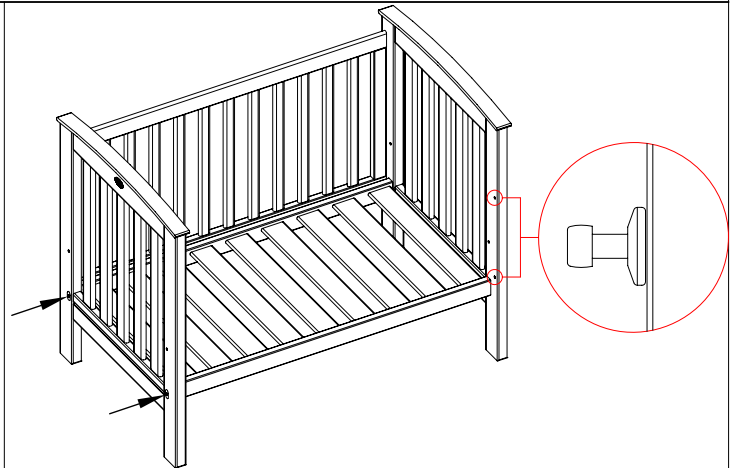

Stage 3:

Push both end panels outward to allow space for assembly of dropside panel.Allow glide pins of one end panel into the runner first.Then allow the pins on the other into the runner by pulling both end panels inward. Ensure that correct side is facing out (see photograph)

Fully screw in the bolts on both end bars of dropside panel.

Tighten all the connecting bolts.(Do not over tighten).Block remaining holes on the end panel with 4 capping bolts and 4 capping nuts provided.

Note:

To disassemble the cot just follow assembly instructions in reverse order.

To lower the dropside panel pull the dropside panel up to the top position.Hold it in that position while using your leg to push (at the centre of bottom bar) inward.Then allow the dropside panel to slide down.

To raise the dropside panel,pull the dropside panel up (from centre of the top bar) until it clicks into the locking position.

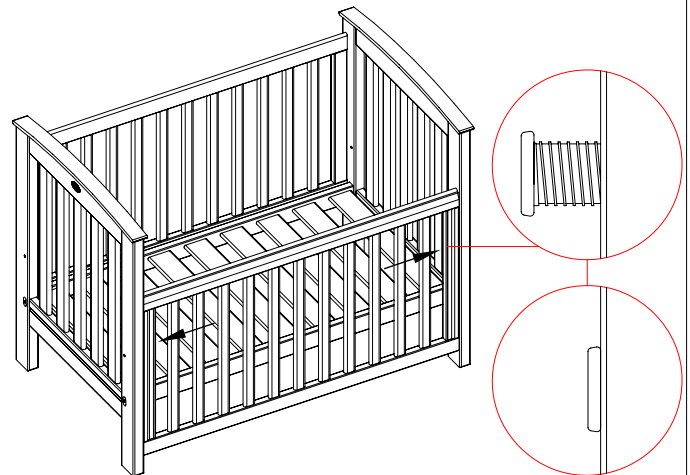

Converting to the Junior Bed:

Remove the drop side (see cot assembly instructions).

Remove the 4 drop side glide pins.

Reposition the base to the lower position (bottom hole of end panels).

Remove the fixed side.

Block the top whole with the 40mm connecting bolts and capping nuts provided.

